



# Monitoring the Internet Connections of WAN Links with Only Routing Configuration

**Asst. Prof. Dr. Ekarin Suethanuwong**

(MTCNA, MTCTCE, MikroTik Academy Trainer, MikroTik Certified Consultant)

Department of Information and Computer Management

Faculty of Commerce and Management, Prince of Songkla University, Thailand

MUM Conference, August 14, 2018, Bangkok, Thailand

# PSU At a Glance...

- 1st University in Southern Thailand, est. 1967
- 5 Campuses
- 36,000 Students (2009)

Surat Thani



Hat Yai



Phuket



Trang



Pattani



# About Me

- Asst. Prof. Dr. **Ekarin Suethanuwong**
- Lecturer at Prince of Songkla University (Trang Campus)
- MikroTik Certificates
  - ✓ MTCNA and MTCTCE
  - ✓ MikroTik Academy Trainer
  - ✓ MikroTik Certified Consultant
- Contact Me
  - ✓ Email: [ekarin.s@psu.ac.th](mailto:ekarin.s@psu.ac.th)
  - ✓ Facebook: [www.facebook.com/ekarin.suethanuwong](http://www.facebook.com/ekarin.suethanuwong)



# What is ISP Failover?

- **ISP Failover** is an operation to automatically **switch over** to the **standby ISP** when a primary ISP fails, i.e. it **cannot provide its Internet service** to the clients.

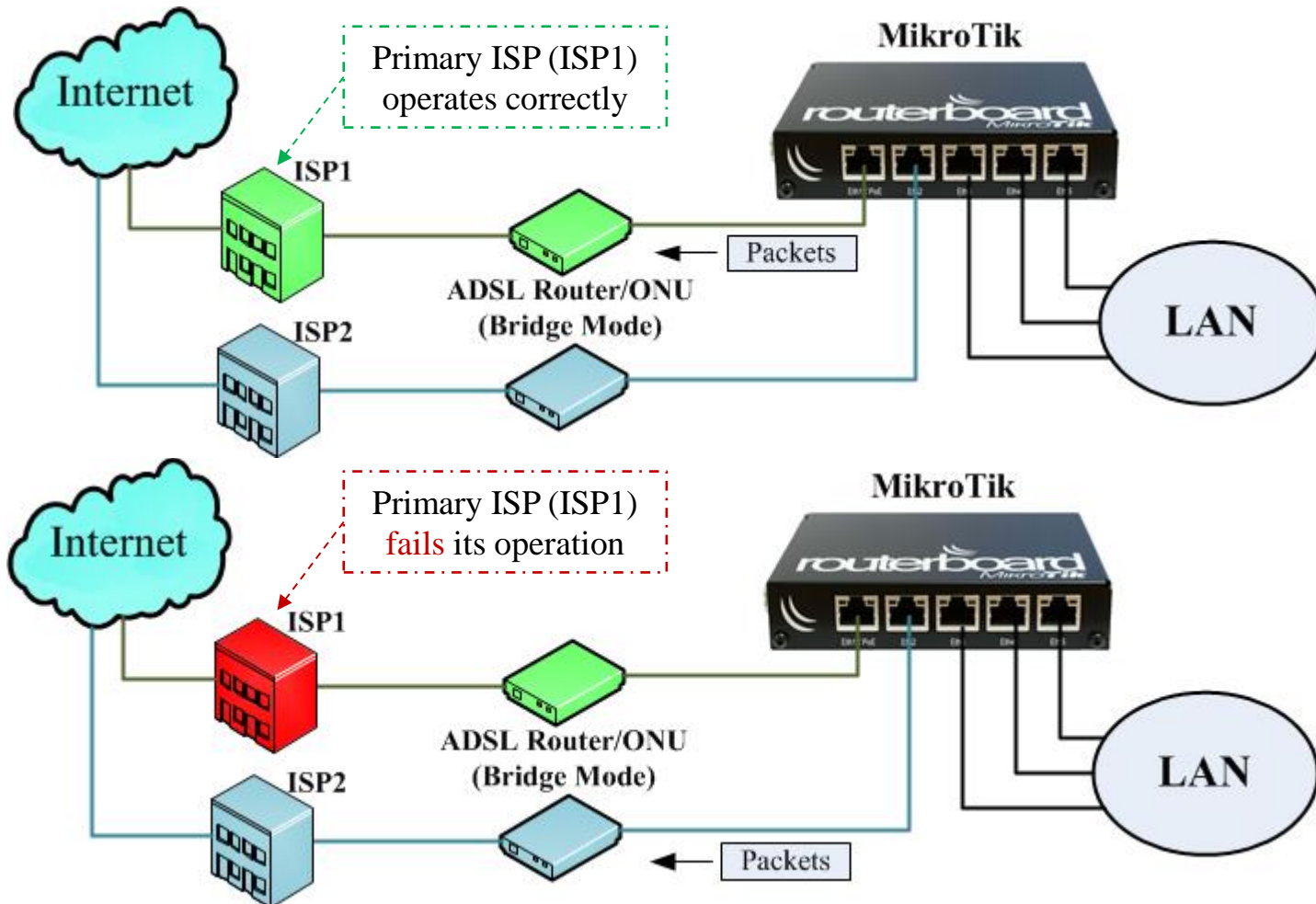

# ISP Failover in MikroTik Routers

- Failover to the standby ISP in MikroTik routers can be simply configured by adding an default route with a higher value of the distance parameter in the routing table. This implies that the default route with a lower distance takes precedence over another one.

```
/ip route add gateway="IP Address of ISP1 Gateway" check-gateway=ping distance=1  
/ip route add gateway="IP Address of ISP2 Gateway" check-gateway=ping distance=2
```

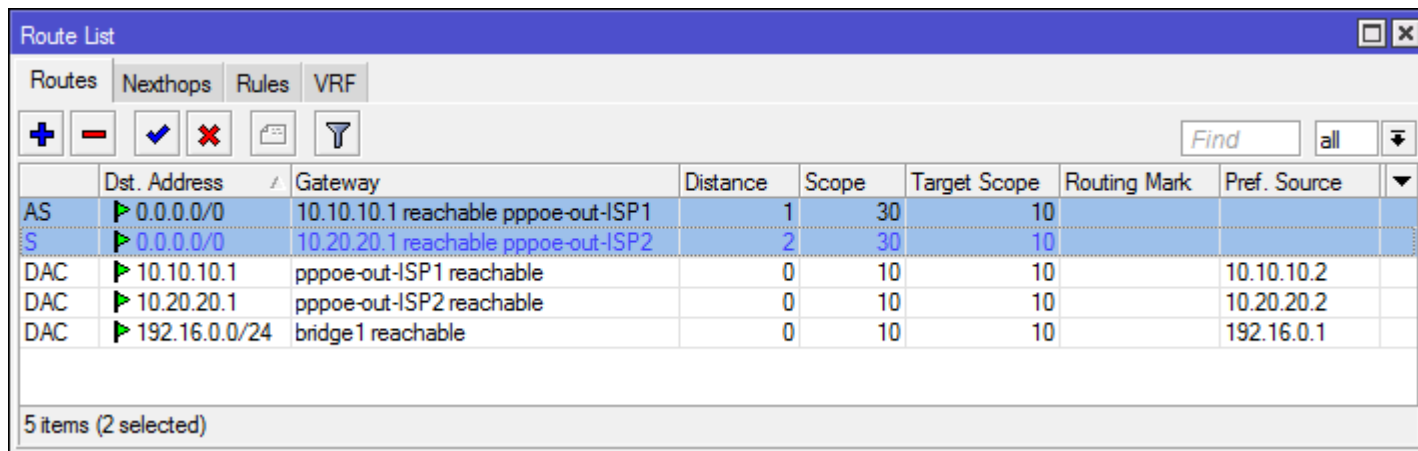

The screenshot shows the 'Route List' window in MikroTik WinBox. The 'Routes' tab is active, displaying a table of routes. Two default routes (0.0.0.0/0) are selected, representing the primary and backup ISPs. The primary route has a distance of 1, and the backup route has a distance of 2. Other routes include specific destinations (10.10.10.1, 10.20.20.1, 192.16.0.0/24) with their respective gateways and distances.

	Dist. Address	Gateway	Distance	Scope	Target Scope	Routing Mark	Pref. Source
AS	0.0.0.0/0	10.10.10.1 reachable pppoe-out-ISP1	1	30	10		
S	0.0.0.0/0	10.20.20.1 reachable pppoe-out-ISP2	2	30	10		
DAC	10.10.10.1	pppoe-out-ISP1 reachable	0	10	10		10.10.10.2
DAC	10.20.20.1	pppoe-out-ISP2 reachable	0	10	10		10.20.20.2
DAC	192.16.0.0/24	bridge1 reachable	0	10	10		192.16.0.1

5 items (2 selected)

# ISP Failover in MikroTik Routers

- Typically, monitoring the down state of an ISP is to **periodically check** the operation of the ISP gateway, i.e. an ICMP request packet is transmitted to **the IP addresses of the ISP gateway** every period of time (10 seconds).
- If the router does not get any ICMP response packet within the two timeouts (i.e. 20 seconds), it determines the ISP **fails**. It will then **indicate the ISP gateway is unreachable** and **switch over the default route of another ISP gateway**.

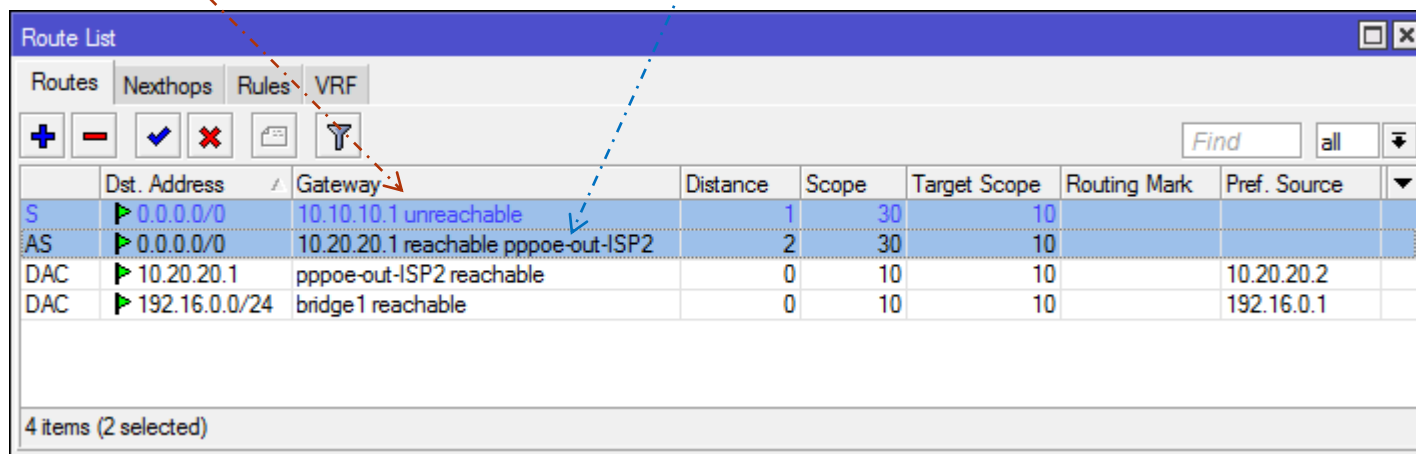

The screenshot shows the 'Route List' window in MikroTik WinBox. The window has tabs for 'Routes', 'Nexthops', 'Rules', and 'VRF'. Below the tabs are several icons: a plus sign, a minus sign, a checkmark, an 'X', a printer icon, and a filter icon. There is also a search box labeled 'Find' with 'all' and a dropdown arrow. The main area contains a table with the following data:

	Dst. Address	Gateway	Distance	Scope	Target Scope	Routing Mark	Pref. Source
S	0.0.0.0/0	10.10.10.1 unreachable	1	30	10		
AS	0.0.0.0/0	10.20.20.1 reachable pppoe-out-ISP2	2	30	10		
DAC	10.20.20.1	pppoe-out-ISP2 reachable	0	10	10		10.20.20.2
DAC	192.16.0.0/24	bridge1 reachable	0	10	10		192.16.0.1

At the bottom of the window, it says '4 items (2 selected)'. A red dashed arrow points from the text 'unreachable' in the first row to the word 'unreachable' in the text above. A blue dashed arrow points from the text 'switch over the default route of another ISP gateway' to the gateway '10.20.20.1 reachable pppoe-out-ISP2' in the second row.

# Typical Problems in ISP Failover

- The **typical problem** is that the router still **get the ICMP responses from the gateway of the primary ISP** but the **Internet cannot be accessible** due to any possible problem behind the primary ISP.
- In this way, all packets that are forwarded to the Internet are still transmitted to the gateway of the primary ISP.

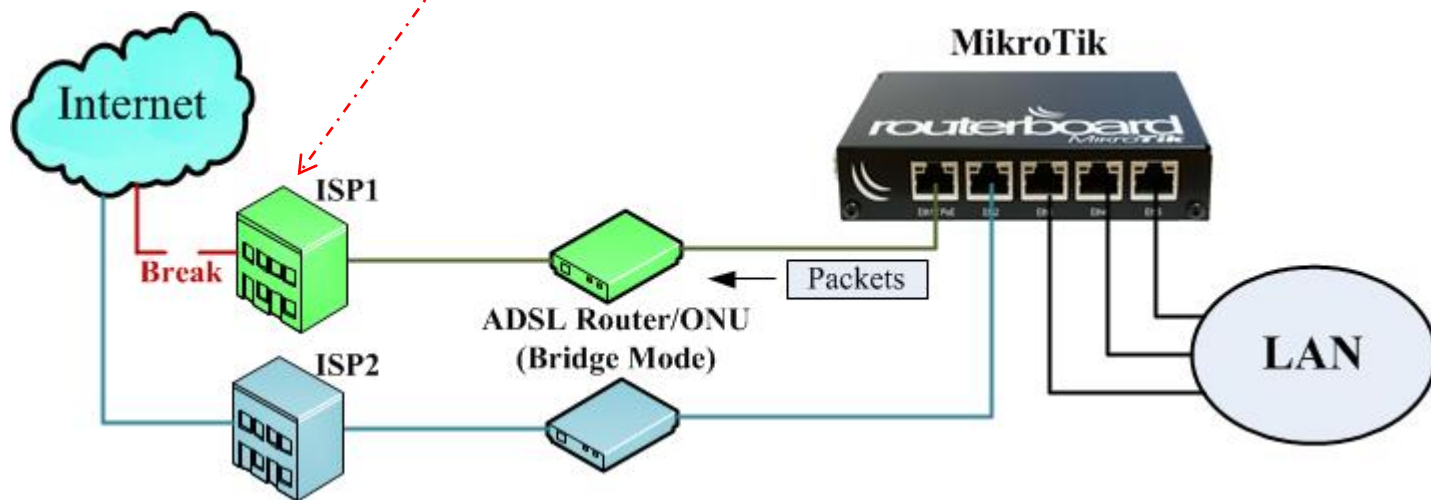

The Internet **cannot be accessible** via ISP1 but the gateway of ISP1 **responses ICMP packets correctly**



# Typical Problems in ISP Failover

- The typical problem is that the router still get the ICMP responses from the gateway of the primary ISP but the Internet cannot be accessible due to any possible problem behind the primary ISP.
- In this way, **all packets that are forwarded to the Internet** are still transmitted to the gateway of the primary ISP.

	Dist. Address	Gateway	Distance	Scope	Target Scope	Routing Mark	Pref. Source
AS	▶ 0.0.0.0/0	10.10.10.1 reachable pppoe-out-ISP1	1	30	10		
S	▶ 0.0.0.0/0	10.20.20.1 reachable pppoe-out-ISP2	2	30	10		
DAC	▶ 10.10.10.1	pppoe-out-ISP1 reachable	0	10	10		10.10.10.2
DAC	▶ 10.20.20.1	pppoe-out-ISP2 reachable					
DAC	▶ 192.16.0.0/24	bridge1 reachable					

```
.. Move up one level
/command Use command at the base level
[admin@MikroTik] > ping google.com
  SEQ HOST                SIZE TTL TIME  STATUS
  0 74.125.24.101          64  64  3000  timeout
  1 74.125.24.101          64  64  3000  timeout
  2 74.125.24.101          64  64  3000  timeout
  3 74.125.24.101          64  64  3000  timeout
  4 74.125.24.101          64  64  3000  timeout
  5 74.125.24.101          64  64  3000  timeout
```



# Typical Problems in ISP Failover

- This is **even worse** in a case where **some ADSL routers or ONU routers** are **not allowed** to configure to be in a **bridge mode**.
- The default root's gateway is **not** the ISP gateway anymore.

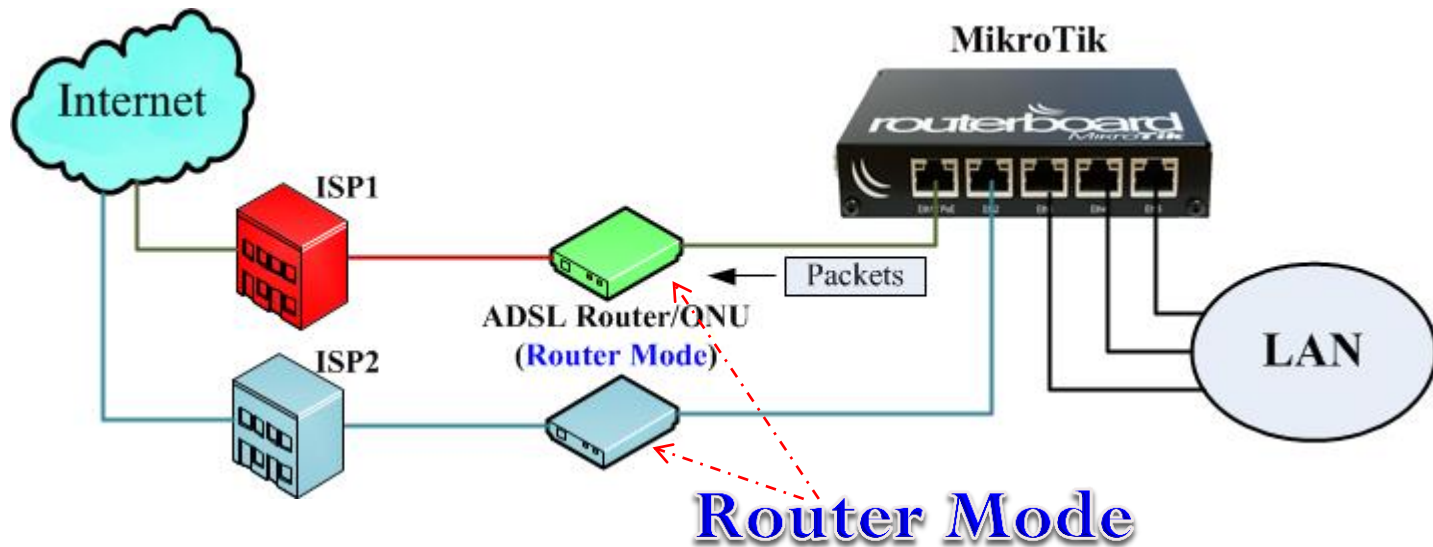

**The default root's gateway is not an ISP gateway**

# Current Solution With Netwatch

- Currently the **Netwatch** tool is **widely used in Thailand** to monitor the Internet connections of WAN links by **checking a remote host** instead of the **nearby gateway**.
- It works like the traditional way by periodically **sending an ICMP request packet** but to **a specified remote host** in the Internet.

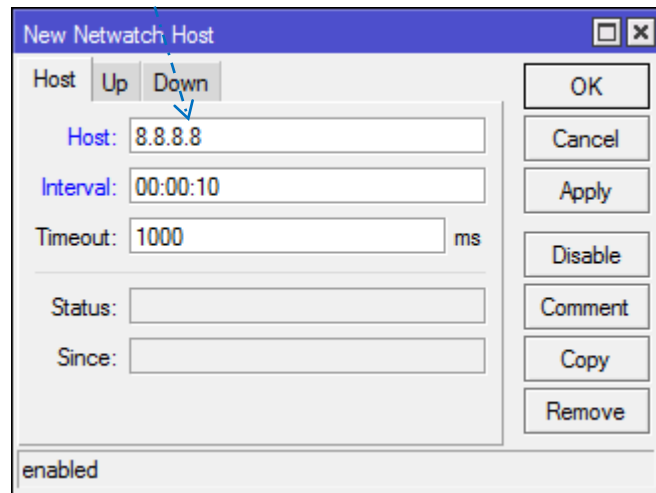

The screenshot shows the 'New Netwatch Host' dialog box. The 'Host' field is set to '8.8.8.8'. The 'Interval' is '00:00:10' and the 'Timeout' is '1000 ms'. The 'Status' and 'Since' fields are empty. The 'enabled' checkbox is checked. A blue dashed arrow points from the text 'a specified remote host' in the list above to the 'Host' field.

Host (8.8.8.8) via the ISP1 gateway

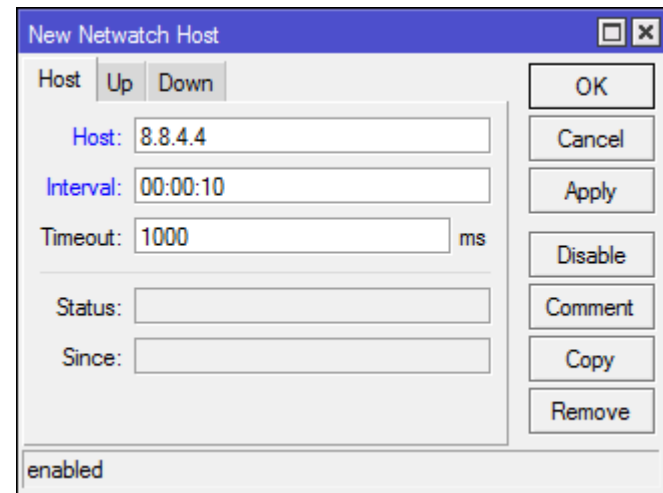

The screenshot shows the 'New Netwatch Host' dialog box. The 'Host' field is set to '8.8.4.4'. The 'Interval' is '00:00:10' and the 'Timeout' is '1000 ms'. The 'Status' and 'Since' fields are empty. The 'enabled' checkbox is checked.

Host (8.8.4.4) via the ISP2 gateway

# Current Solution With Netwatch

- However **scripting** is needed to **disable and enable default routes (by finding their comments)** in case where the up and down events of the remote hosts occur.

**Host (8.8.8.8)  
for ISP1**

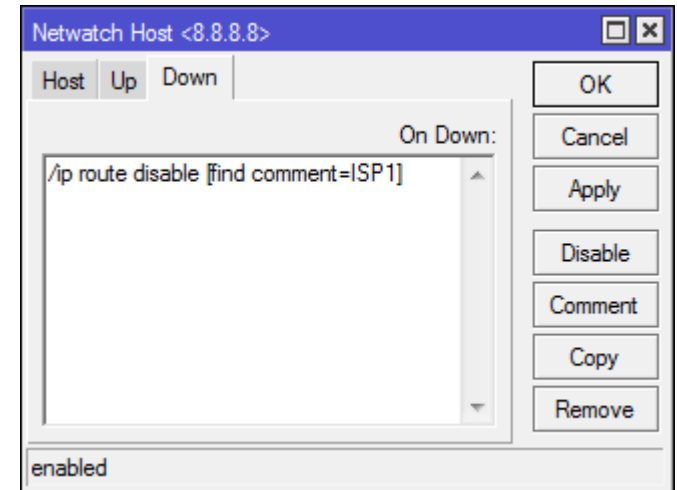
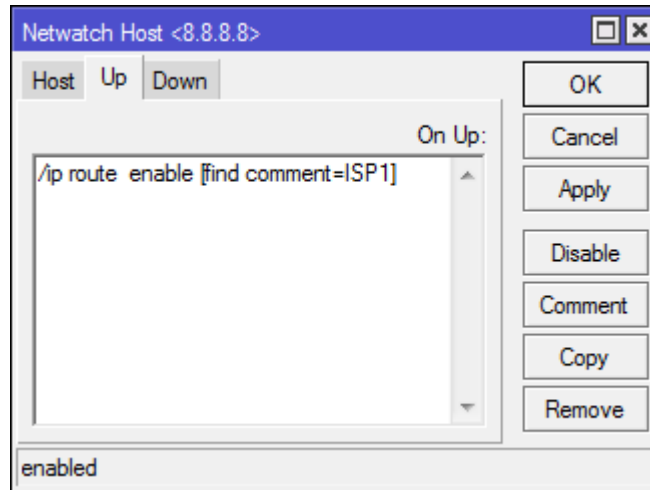

**Host (8.8.4.4)  
for ISP2**

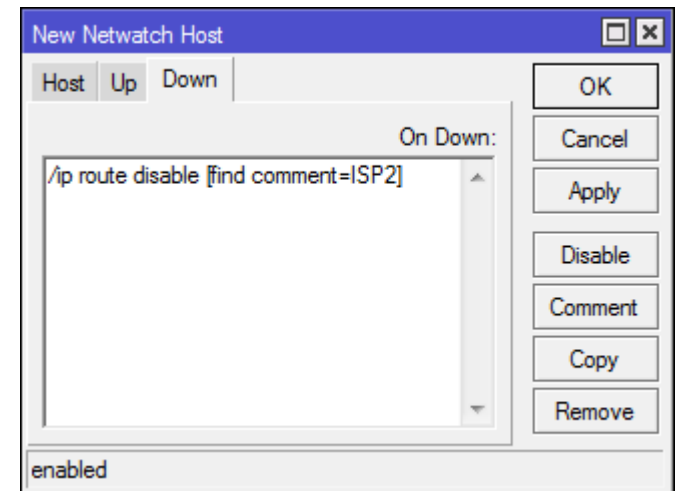
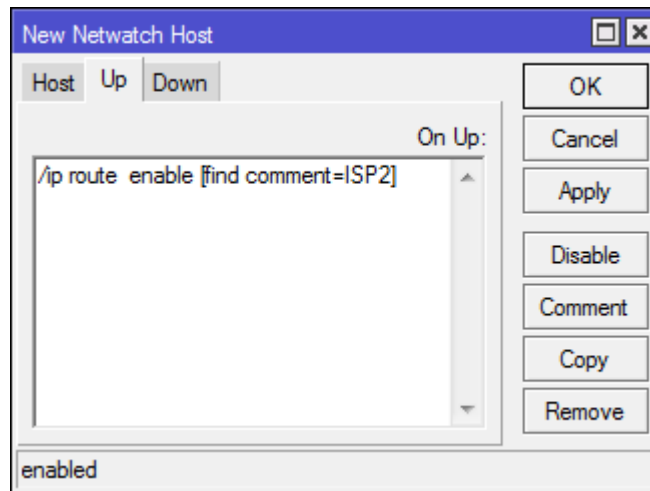

# Current Solution With Netwatch

- However **scripting in the Netwatch tool** is needed to **disable and enable default routes (by finding their comments)** in case where the **up and down** events of the remote host occur.

```
/tool netwatch
add down-script="/ip route disable [find comment=ISP1]" host=8.8.8.8 \
  interval=10s up-script="/ip route enable [find comment=ISP1]"
add down-script="/ip route disable [find comment=ISP2]" host=8.8.4.4 \
  interval=10s up-script="/ip route enable [find comment=ISP2]"
```

- Each default route will be **disabled** and **enabled** by referring its **comment** parameter.

```
/ip route
add check-gateway=ping comment=ISP1 distance=1 gateway=10.10.10.1
add check-gateway=ping comment=ISP2 distance=2 gateway=10.20.20.1
```

- The Netwatch tasks will ping each remote hosts via a different route (or gateway).

```
/ip route
add check-gateway=ping comment="Netwatch ISP2" distance=1 dst-address=\
  8.8.4.4/32 gateway=10.20.20.1
add check-gateway=ping comment="Netwatch ISP1" distance=1 dst-address=\
  8.8.8.8/32 gateway=10.10.10.1
```

# Scripting in Netwatch

- It can be said that such **scripting** is **not easy to accomplish for technicians** who want to implement network solutions with failover for their customers but **they do not know much about scripting**. They prefer to simply configure via WinBox with GUI.

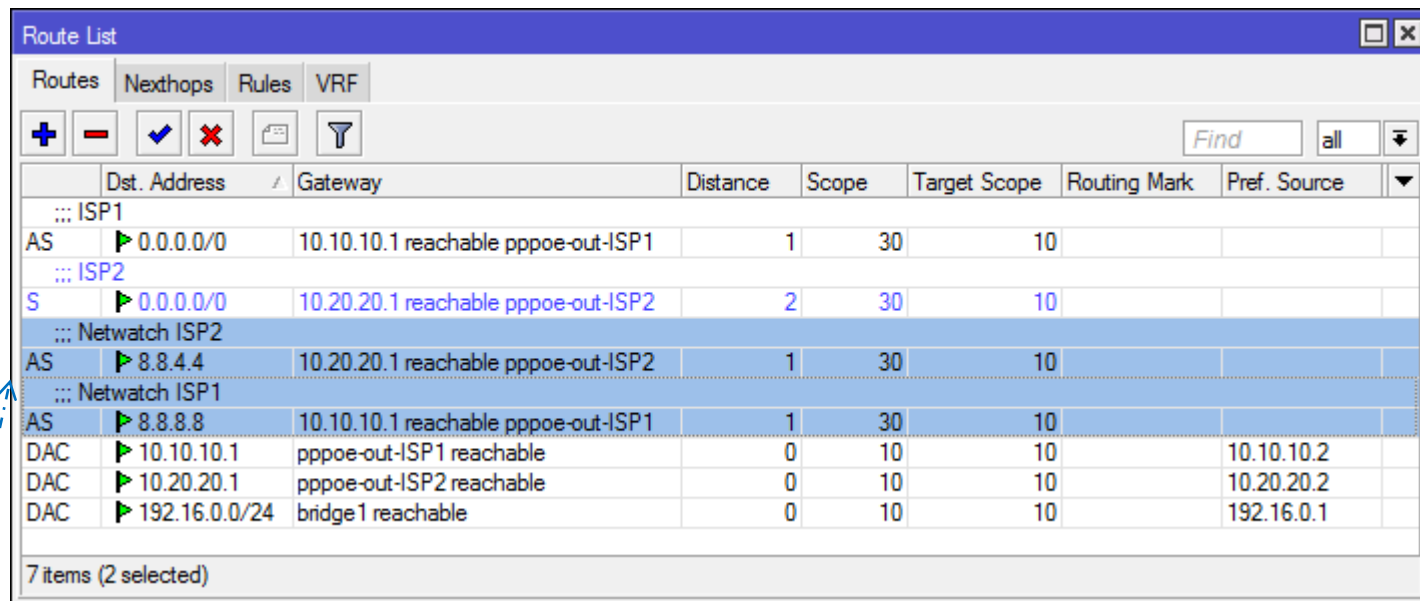

	Dist. Address	Gateway	Distance	Scope	Target Scope	Routing Mark	Pref. Source
::: ISP1							
AS	0.0.0.0/0	10.10.10.1 reachable pppoe-out-ISP1	1	30	10		
::: ISP2							
S	0.0.0.0/0	10.20.20.1 reachable pppoe-out-ISP2	2	30	10		
::: Netwatch ISP2							
AS	8.8.4.4	10.20.20.1 reachable pppoe-out-ISP2	1	30	10		
::: Netwatch ISP1							
AS	8.8.8.8	10.10.10.1 reachable pppoe-out-ISP1	1	30	10		
DAC	10.10.10.1	pppoe-out-ISP1 reachable	0	10	10		10.10.10.2
DAC	10.20.20.1	pppoe-out-ISP2 reachable	0	10	10		10.20.20.2
DAC	192.16.0.0/24	bridge1 reachable	0	10	10		192.16.0.1

7 items (2 selected)

- Routes for remote hosts (i.e. 8.8.8.8 via the ISP1 gateway and 8.8.4.4 via the ISP2 gateway) must be added and always available for the Netwatch tool's tasks.

# Scripting in Netwatch

- The default root with the ISP1 comment is **disabled** when the Netwatch does not get an ICMP response packet for a specified timeout (1 second) after sending an ICMP request packet via the ISP1 gateway (10.10.10.1).

	Dst. Address	Gateway	Distance	Routing Mark	Pref. Source
::: ISP1	0.0.0.0/0	10.10.10.1	1		
::: ISP2	0.0.0.0/0	10.20.20.1 reachable pppoe-out-ISP2	2		
::: Netwatch ISP2	8.8.4.4	10.20.20.1 reachable pppoe-out-ISP2	1		
::: Netwatch ISP1	8.8.8.8	10.10.10.1 reachable pppoe-out-ISP1	1		
DAC	10.10.10.1	pppoe-out-ISP1 reachable	0		10.10.10.2
DAC	10.20.20.1	pppoe-out-ISP2 reachable	0		10.20.20.2
DAC	192.16.0.0/24	bridge1 reachable	0		192.16.0.1

7 items (1 selected)

Host	Interval	Timeout (ms)	Status	Since
8.8.4.4	00:00:10	1000	up	Jun/19/2018 15:50:58
8.8.8.8	00:00:10	1000	Down	Jun/19/2018 15:56:53

2 items (1 selected)

# Multiple Remote Hosts with Netwatch

- It is possible that a single remote host might be down, checking multiple remote hosts per WAN link (such as Google DNS and OpenDNS) is required to confirm whether the Internet connection is really available per WAN link.
- In this regard, using the Netwatch tool seems to be unable to cope with because it supports only a single remote host.

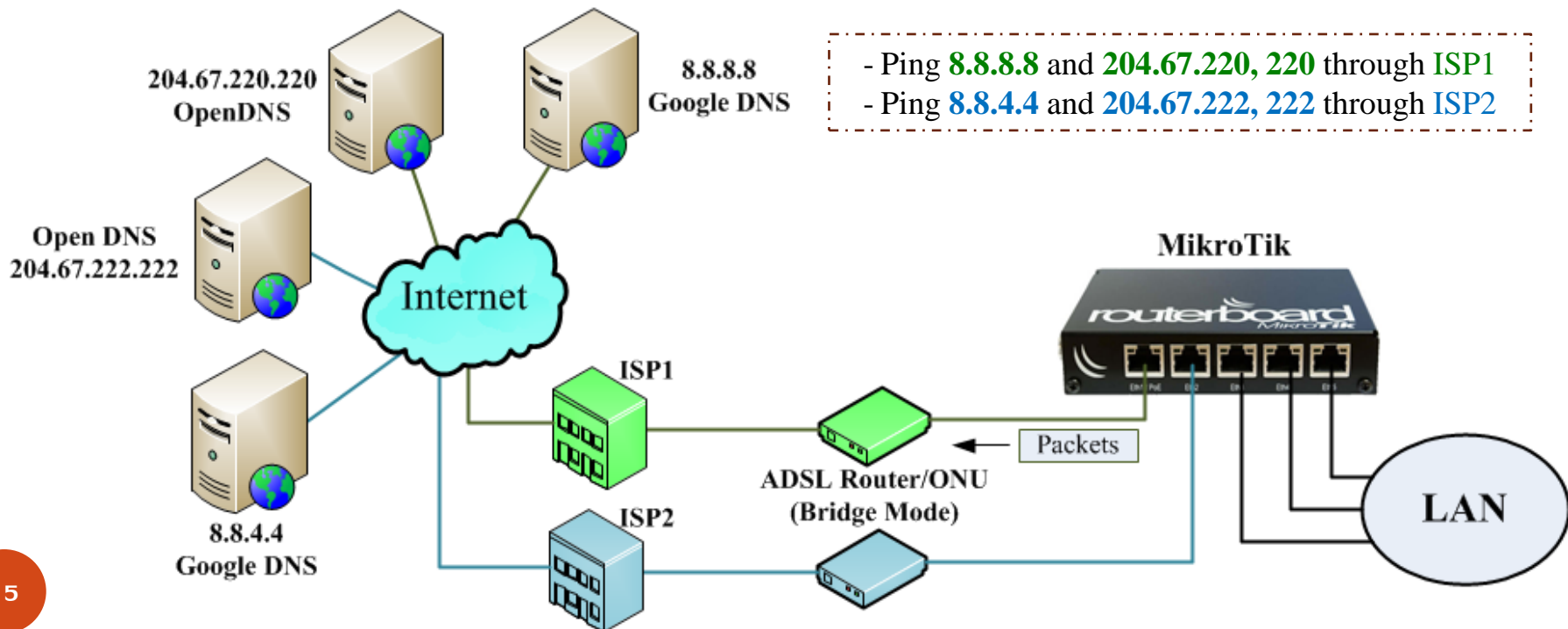



# Solution with Only Routing Configuration

- An **alternative solution** that can figure out the previously mentioned problems is done by **configuring only routes** in the routing table (**/ip routes**) **without scripting and using the Netwatch tool at all**.
- This solution can be broken down into **two scenarios**:
  - 1) Failover with **checking a single remote host** per WAN link
  - 2) Failover with **checking multiple remote hosts** per WAN link

No Scripting & Netwatch

Only Routing Configuration

Being Able to Check Multiple Remote Hosts per WAN Link

## Reference

[1] <https://wiki.mikrotik.com/wiki/Manual:IP/Route>

[2] [https://wiki.mikrotik.com/wiki/Advanced\\_Routing\\_Failover\\_without\\_Scripting](https://wiki.mikrotik.com/wiki/Advanced_Routing_Failover_without_Scripting)

# Basic Configuration with Two ISPs

- For **demonstration**, two (MikroTik) routers are used.
  - ✓ MikroTik(A) emulates ISP1 and ISP2 via Ether1 and Ether2, respectively.
  - ✓ MikroTik(B) emulates a router in a customer house.
- Both ISP1 and ISP2 provide IP addresses to the customer's router via PPPoE
  - ✓ At the **ISP1**, Local Address = **10.10.10.1**, Remote Address = **10.10.10.2**
  - ✓ At the **ISP2**, Local Address = **10.20.20.1**, Remote Address = **10.20.20.2**

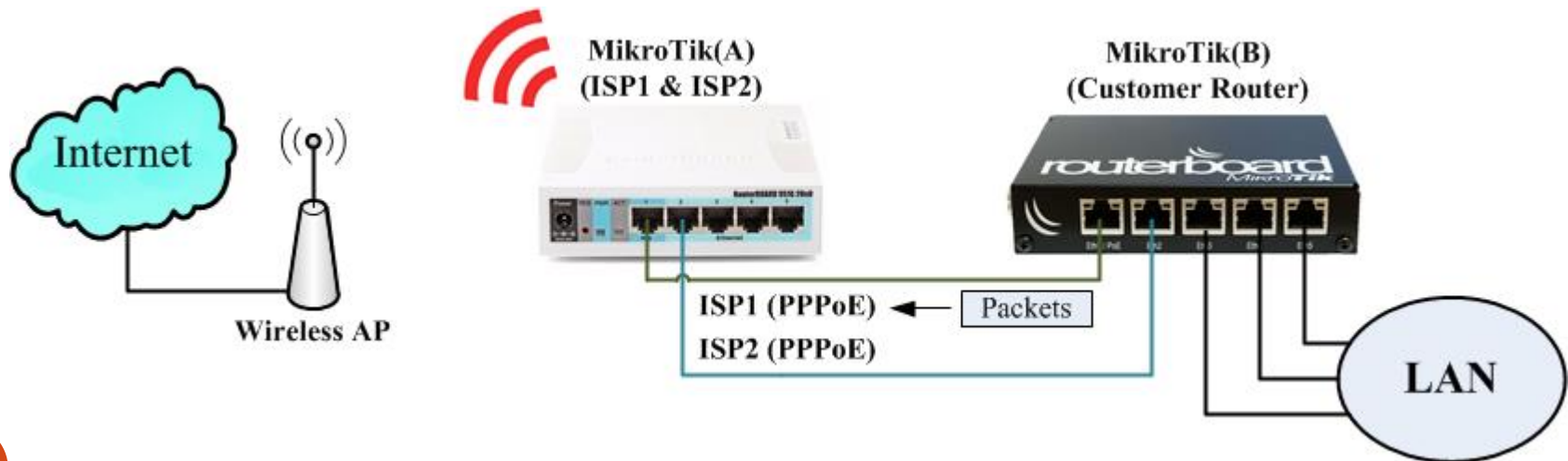

# Basic Configuration with Two ISPs

- At [the customer router](#), the basic configuration is described by the following scripts.

- PPPoE Clients for ISP1 and ISP2

```
/interface pppoe-client
add disabled=no interface=ether1 name=pppoe-out-ISP1 password=12345 \
    use-peer-dns=yes user=user1
add disabled=no interface=ether2 name=pppoe-out-ISP2 password=12345 \
    use-peer-dns=yes user=user2
```

- Bridge with ether3, ether4, ether5

```
/interface bridge
add name=bridg1

/interface bridge port
add bridge=bridg1 interface=ether3
add bridge=bridg1 interface=ether4
add bridge=bridg1 interface=ether5
```

- Bridge's IP Address as 192.168.0.1/24

```
/ip address
add address=192.16.0.1/24 interface=bridg1 network=192.16.0.0
```

# Basic Configuration with Two ISPs

- At [the customer router](#), the basic configuration is described by the following scripts.
- DHCP Server with a pool of 192.168.0.2-192.168.0.254

```
/ip pool
add name=dhcp_pool1 ranges=192.16.0.2-192.16.0.254

/ip dhcp-server
add address-pool=dhcp_pool1 disabled=no interface=bridge1 name=dhcp1

/ip dhcp-server network
add address=192.16.0.0/24 gateway=192.16.0.1
```

- DNS Server in the customer router

```
/ip dns
set allow-remote-requests=yes
```

- NAT for the PPPoE Clients of ISP1 and ISP2

```
/ip firewall nat
add action=masquerade chain=srcnat out-interface=pppoe-out-ISP1
add action=masquerade chain=srcnat out-interface=pppoe-out-ISP2
```

# Failover with Checking a Single Remote Host

- Failover with **checking a single remote host** per WAN link
- 1) Create **default routes** using **remote hosts as gateways** with different distances
  - /ip route

add distance=1 gateway=8.8.8.8 check-gateway=ping

add distance=2 gateway=8.8.4.4 check-gateway=ping

	Dst. Address	Gateway	Check Gateway	Distance	Scope	Pref. Source
: ISP1						
S	0.0.0.0/0	8.8.8.8 unreachable	ping	1	30	
:: ISP2						
S	0.0.0.0/0	8.8.4.4 unreachable	ping	2	30	
DAC	10.10.10.1	pppoe-out-ISP1 reachable		0	10	10.10.10.2
DAC	10.20.20.1	pppoe-out-ISP2 reachable		0	10	10.20.20.2
DAC	192.16.0.0/24	bridge 1 reachable		0	10	192.16.0.1

5 items (2 selected)

**Remote hosts are unreachable**

# Failover with Checking a Single Remote Host

- Failover with **checking a single remote host** per WAN link
- 2) Create **routes to the remote hosts** using **corresponding ISP gateways** with **scope=10** (the **scope** parameter must be **less or equal** to the target score parameter)
- `/ip route`

add dst-address=8.8.8.8 gateway=10.10.10.1 **scope=10**

add dst-address=8.8.4.4 gateway=10.20.20.1 **scope=10**

**Remote hosts are now reachable**

	Dst. Address	Gateway	Check Gateway	Distance	Scope	Pref. Source
::: ISP1						
AS	▶ 0.0.0.0/0	8.8.8.8 recursive via 10.10.10.1 pppoe-out-ISP1 ping		1	30	
::: ISP2						
S	▶ 0.0.0.0/0	8.8.4.4 recursive via 10.20.20.1 pppoe-out-ISP2 ping		2	30	
::: Dst.Address to 8.8.4.4 via ISP2 Gateway						
AS	▶ 8.8.4.4	10.20.20.1 reachable pppoe-out-ISP2		1	10	
::: Dst.Address to 8.8.8.8 via ISP1 Gateway						
AS	▶ 8.8.8.8	10.10.10.1 reachable pppoe-out-ISP1		1	10	
DAC	▶ 10.10.10.1	pppoe-out-ISP1 reachable		0	10	10.10.10.2
DAC	▶ 10.20.20.1	pppoe-out-ISP2 reachable		0	10	10.20.20.2
DAC	▶ 192.16.0.0/24	bridge1 reachable		0	10	192.16.0.1

7 items (2 selected)

# Failover with Checking Single Remote Hosts

- **Testing:** failover with **checking a single remote host** per WAN link
- **Scenario#1:** The **ISP1 fails** to access the Internet, the firewall rule in the MikroTik(A) **drops all packets from the ISP1 PPPoE** to the Internet. The backup WAN link (to ISP2) should take over all packets to the Internet.

The screenshot displays two windows from MikroTik WinBox:

- Firewall:** Shows a table of filter rules. Rule 0 is selected, with Action 'drop', Chain 'forward', Src. Address empty, Dst. Address empty, Protocol empty, In. Interface '<pppoe-user1>', and Out. Interface 'wlan1'. The Bytes column shows '280 B' and Packets shows '5'. Rule 1 is also shown with Action 'drop' and Out. Interface 'wlan1'.
- Route List:** Shows a table of routes. The top two routes are selected: one for ISP1 (0.0.0.0/0 via 8.8.8.8) and one for ISP2 (0.0.0.0/0 via 8.8.4.4). A note 'AS = Active Static' points to the ISP2 route. Below these are specific routes for 8.8.4.4 and 8.8.8.8, and several DAC routes for local networks.

Annotations:

- A dashed box labeled 'ISP Sites' points to the Firewall window.
- A dashed box labeled 'Customer Site' points to the Route List window.



# Failover with Checking Single Remote Hosts

- **Testing:** failover with **checking a single remote host** per WAN link
- **Scenario#2:** The **primary ISP1 has been recovered** to be accessible to the Internet, the firewall rule in the MikroTik(A) that drops all packets from the ISP1 is **disabled**. The **WAN link (ISP1)** should return to take over all packets to the Internet.

The image shows two screenshots from MikroTik WinBox. The top screenshot is the Firewall configuration window, showing two filter rules. The bottom screenshot is the Route List window, showing routes for ISP1 and ISP2. Annotations include a dashed box labeled 'ISP Sites' pointing to the Firewall window, a dashed box labeled 'Customer Site' pointing to the Route List window, and a text label 'AS = Active Static' with an arrow pointing to the AS route in the Route List.

**Firewall Configuration:**

#	Action	Chain	Src. Address	Dst. Address	Protocol	In. Interface	Out. Interface	Bytes	Packets
0	X drop	forward				<pppoe-user1>	wlan1	4256 B	76
1	X drop	forward				<pppoe-user2>	wlan1	0 B	0

**Route List Configuration:**

Routes	Nexthops	Rules	VRF	Find	all
::: ISP1					
AS	▶ 0.0.0.0/0	8.8.8.8 recursive via 10.10.10.1 pppoe-out-ISP1 ping		1	30
::: ISP2					
S	▶ 0.0.0.0/0	8.8.4.4 recursive via 10.20.20.1 pppoe-out-ISP2 ping		2	30
::: Dst.Address to 8.8.4.4 via ISP2 Gateway					
AS	▶ 8.8.4.4	10.20.20.1 reachable pppoe-out-ISP2		1	10
::: Dst.Address to 8.8.8.8 via ISP1 Gateway					
AS	▶ 8.8.8.8	10.10.10.1 reachable pppoe-out-ISP1		1	10
DAC	▶ 10.10.10.1	pppoe-out-ISP1 reachable		0	10 10.10.10.2
DAC	▶ 10.20.20.1	pppoe-out-ISP2 reachable		0	10 10.20.20.2
DAC	▶ 192.16.0.0/24	bridge1 reachable		0	10 192.16.0.1

# Failover with Checking a Single Remote Host

- Failover with **checking a single remote host** per WAN link
- In case of **load balancing**, you have corresponding **routing masks** (toISP1, toISP2)
- The **first step 1)** is revised (**adding default routes and changing distances**) as follow.
  - /ip route
    - add distance=1 gateway=8.8.8.8 **routing-mask=toISP1** check-gateway=ping
    - add distance=2** gateway=8.8.4.4 **routing-mask=toISP1** check-gateway=ping
  - /ip route
    - add distance=**1** gateway=8.8.4.4 **routing-mask=toISP2** check-gateway=ping
    - add distance=2** gateway=8.8.8.8 **routing-mask=toISP2** check-gateway=ping

# Failover with Checking Multiple Remote Hosts

- Failover with **checking multiple remote hosts** per WAN link
- **Google DNS** (8.8.8.8, 8.8.4.4) and **OpenDNS** (204.67.220.220, 204.67.222.222) are well known as **trustable and stable DNS servers**.

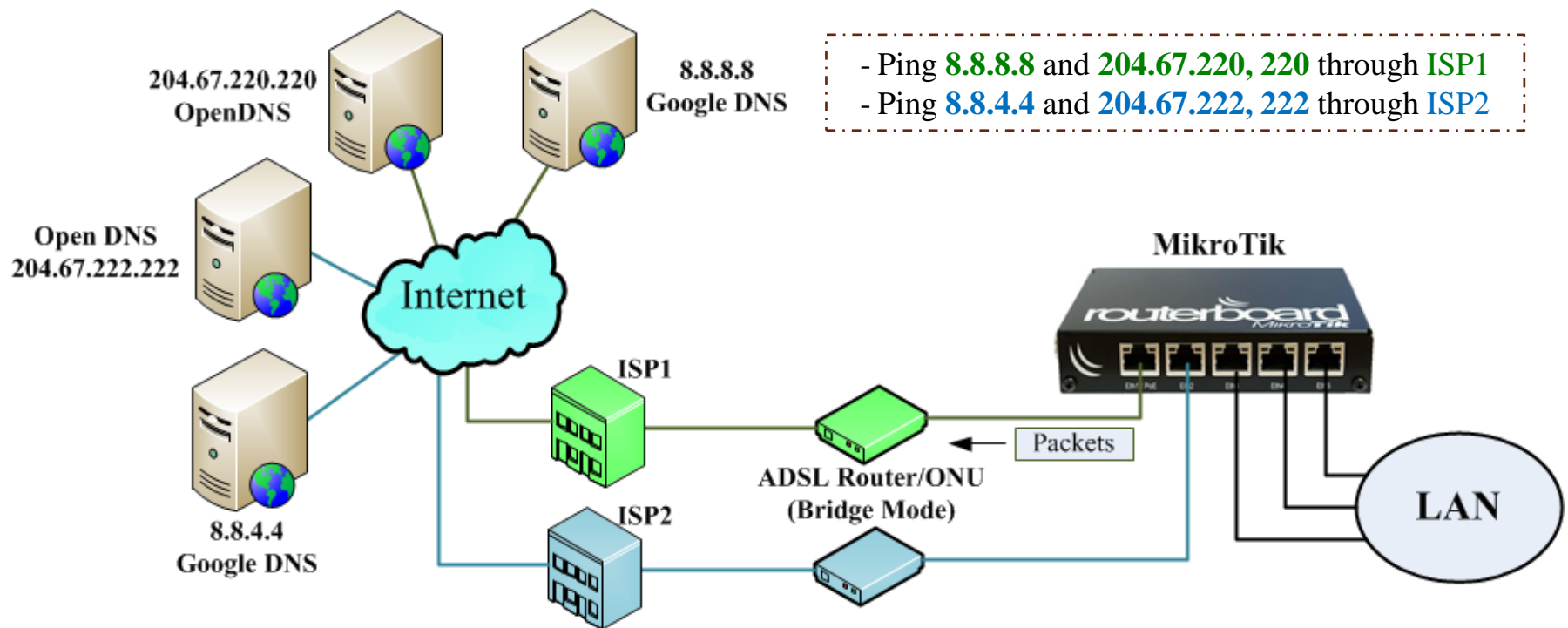

# Failover with Checking Multiple Remote Hosts

- Failover with **checking multiple remote hosts** per WAN link
- Monitoring the **primary WAN link's state** by checking Host1A, Host1B via GW1
  - Given Host1A = **8.8.8.8** and Host1B = **208.67.220.220**
- Monitoring the **backup WAN link's state** by checking Host2A, Host2B via GW2
  - Given Host2A = **8.8.4.4** and Host2B = **208.67.222.222**

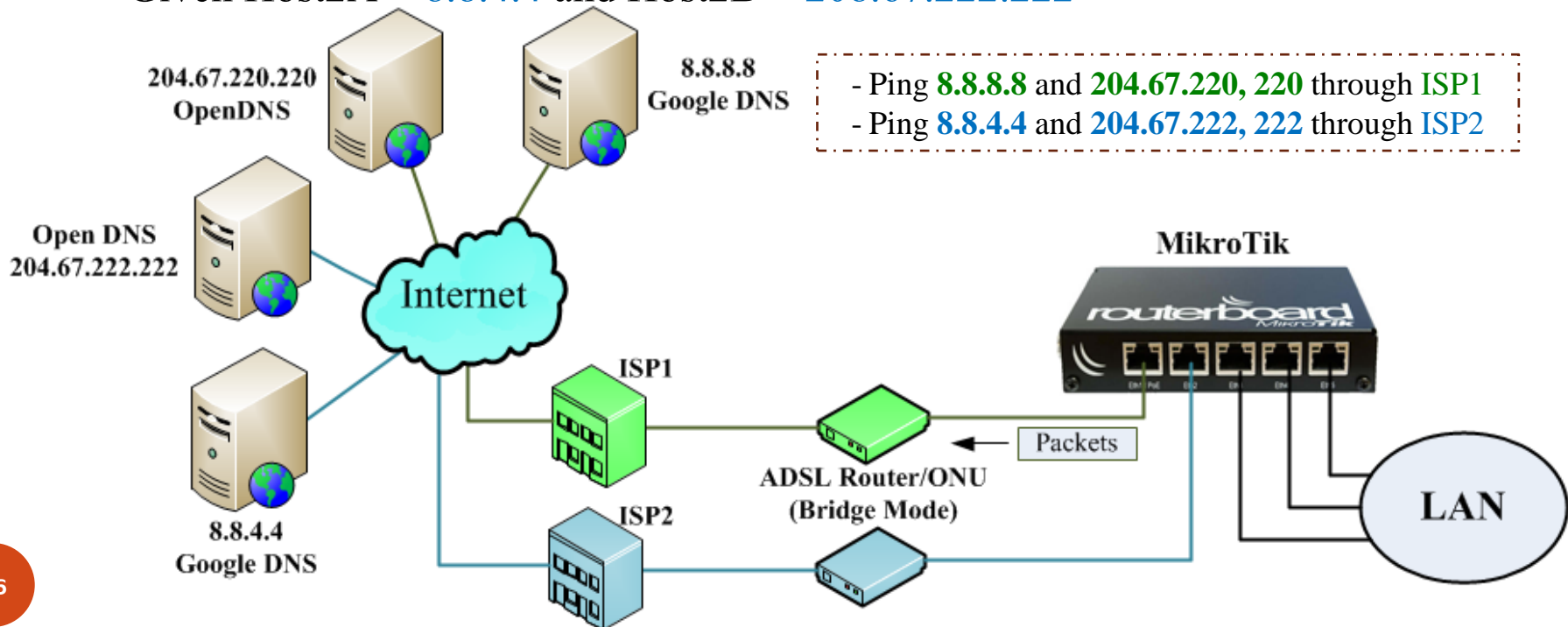

# Failover with Checking Multiple Remote Hosts

- Failover with **checking multiple remote hosts** per WAN link
- 1) Create **default routes** using **remote hosts as gateways** with **different distances**, but instead of using remote hosts, **two virtual hops** (10.1.1.1 for GW1 and 10.2.2.2 for GW2) has been setup as corresponding gateways to simplify the default routes.
- /ip route

add distance=1 gateway=10.1.1.1

add distance=2 gateway=10.2.2.2

	Dst. Address	Gateway	Check Gateway	Distance	Scope	Pref. Source
::: ISP1						
S	0.0.0.0/0	10.1.1.1 unreachable	ping	1	30	
::: ISP2						
S	0.0.0.0/0	10.2.2.2 unreachable	ping	2	30	
DAC	10.10.10.1	pppoe-out-ISP1 reachable		0	10	10.10.10.2
DAC	10.20.20.1	pppoe-out-ISP2 reachable		0	10	10.20.20.2
DAC	192.16.0.0/24	bridge1 reachable		0	10	192.16.0.1

5 items (2 selected)

# Failover with Checking Multiple Remote Hosts

- Failover with **checking multiple remote hosts** per WAN link
- 2) Create **routes to the virtual hops** using corresponding multiple remote hosts with **scope=10**
  - `/ip route`
    - add `dst-address=10.1.1.1 gateway=8.8.8.8 scope=10 check-gateway=ping`
    - add `dst-address=10.1.1.1 gateway=208.67.220.220 scope=10 check-gateway=ping`
  - `/ip route`
    - add `dst-address=10.2.2.2 gateway=8.8.4.4 scope=10 check-gateway=ping`
    - add `dst-address=10.2.2.2 gateway=208.67.222.222 scope=10 check-gateway=ping`

# Failover with Checking Multiple Remote Hosts

- Failover with **checking multiple remote hosts** per WAN link
- 2) Create **routes to the virtual hops** using corresponding multiple remote hosts with **scope=10**

	Dst. Address	Gateway	Check Gateway	Distance	Scope	Pref. Source
::: ISP1						
S	0.0.0.0/0	10.1.1.1 unreachable		1	30	
::: ISP2						
S	0.0.0.0/0	10.2.2.2 unreachable		2	30	
::: Virtual Hop 10.1.1.1 via Gateway 8.8.8.8						
S	10.1.1.1	8.8.8.8 unreachable	ping	1	10	
::: Virtual Hop 10.1.1.1 via Gateway 208.67.220.220						
S	10.1.1.1	208.67.220.220 unreachable	ping	1	10	
::: Virtual Hop 10.2.2.2 via Gateway 8.8.4.4						
S	10.2.2.2	8.8.4.4 unreachable	ping	1	10	
::: Virtual Hop 10.2.2.2 via Gateway 208.67.222.222						
S	10.2.2.2	208.67.222.222 unreachable	ping	1	10	
DAC	10.10.10.1	pppoe-out-ISP1 reachable		0	10	10.10.10.2
DAC	10.20.20.1	pppoe-out-ISP2 reachable		0	10	10.20.20.2
DAC	192.16.0.0/24	bridge1 reachable		0	10	192.16.0.1

9 items (4 selected)

Remote hosts are **unreachable**. No routes with the scope 10



# Failover with Checking Multiple Remote Hosts

- Failover with **checking multiple remote hosts** per WAN link
- 3) Create **routes to the remote hosts** using corresponding ISP gateways with **scope=10**  
(the **scope** parameter must be **less or equal** to the target score parameter)

- `/ip route`

```
add dst-address=8.8.8.8 gateway=10.10.10.1 scope=10
```

```
add dst-address=208.67.220.220 gateway=10.10.10.1 scope=10
```

- `/ip route`

```
add dst-address=8.8.4.4 gateway=10.20.20.1 scope=10
```

```
add dst-address=208.67.222.222 gateway=10.20.20.1 scope=10
```

# Failover with Checking Multiple Remote Hosts

- Failover with **checking multiple remote hosts** per WAN link
- 3) Create **routes to the remote hosts** using corresponding ISP gateways with **scope=10**  
(the scope parameter must be **less or equal** to the target score parameter)

Route List

Routes Nexthops Rules VRF

Find all

	Dst. Address	Gateway	Check Gateway	Distance	Scope	Pref. Source
::: ISP1						
AS	0.0.0.0/0	10.1.1.1 recursive via 10.10.10.1 pppoe-out-ISP1		1	30	
::: ISP2						
S	0.0.0.0/0	10.2.2.2 recursive via 10.20.20.1 pppoe-out-ISP2		2	30	
::: Route to 8.8.4.4 via Gateway 10.20.20.1						
AS	8.8.4.4	10.20.20.1 reachable pppoe-out-ISP2		1	10	
::: Route to 8.8.8.8 via Gateway 10.10.10.1						
AS	8.8.8.8	10.10.10.1 reachable pppoe-out-ISP1		1	10	
::: Virtual Hop 10.1.1.1 via Gateway 8.8.8.8						
AS	10.1.1.1	8.8.8.8 recursive via 10.10.10.1 pppoe-out-ISP1	ping	1	10	
::: Virtual Hop 10.1.1.1 via Gateway 208.67.220.220						
S	10.1.1.1	208.67.220.220 recursive via 10.10.10.1 pppoe-out-ISP1	ping	1	10	
::: Virtual Hop 10.2.2.2 via Gateway 8.8.4.4						
AS	10.2.2.2	8.8.4.4 recursive via 10.20.20.1 pppoe-out-ISP2	ping	1	10	
::: Virtual Hop 10.2.2.2 via Gateway 208.67.222.222						
S	10.2.2.2	208.67.222.222 recursive via 10.20.20.1 pppoe-out-ISP2	ping	1	10	
::: Route to 208.67.220.220 via Gateway 10.10.10.1						
AS	208.67.220.220	10.10.10.1 reachable pppoe-out-ISP1		1	10	
::: Route to 208.67.222.222 via Gateway 10.20.20.1						
AS	208.67.222.222	10.20.20.1 reachable pppoe-out-ISP2		1	10	
DAC	10.10.10.1	pppoe-out-ISP1 reachable		0	10	10.10.10.2
DAC	10.20.20.1	pppoe-out-ISP2 reachable		0	10	10.20.20.2
DAC	192.16.0.0/24	bridge1 reachable		0	10	192.16.0.1

13 items (4 selected)

Remote hosts are now reachable

# Failover with Checking Multiple Remote Hosts

- Failover with **checking multiple remote hosts** per WAN link
- The result of manually adding such routes with **the scope 10** can be checked in term of **next hop** (/ip route nexthop print). Note that such routes are **not connected routes**.
- The **gateway** state “**recursive**” denotes that the gateway is used as the destination address for the next round in finding the next appropriate route (with the scope 10) in the route list.

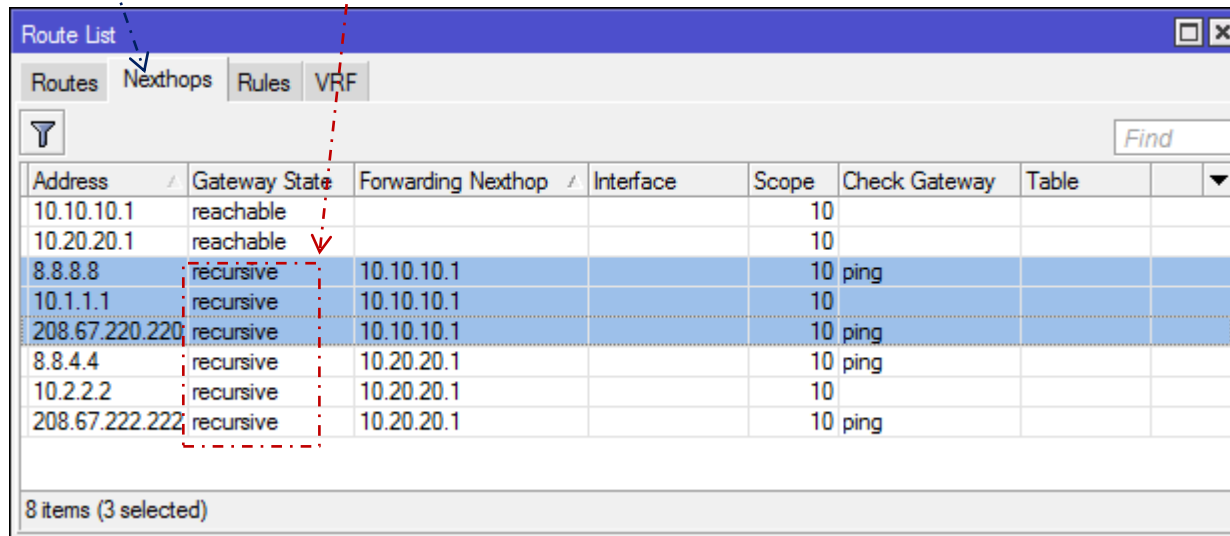

Address	Gateway State	Forwarding Nexthop	Interface	Scope	Check Gateway	Table
10.10.10.1	reachable			10		
10.20.20.1	reachable			10		
8.8.8.8	recursive	10.10.10.1		10	ping	
10.1.1.1	recursive	10.10.10.1		10		
208.67.220.220	recursive	10.10.10.1		10	ping	
8.8.4.4	recursive	10.20.20.1		10	ping	
10.2.2.2	recursive	10.20.20.1		10		
208.67.222.222	recursive	10.20.20.1		10	ping	

8 items (3 selected)

# Failover with Checking Multiple Remote Hosts

- **Testing:** failover with **checking multiple remote hosts** per WAN link
- **Scenario#1:** The ISP1 fails to access the Internet, the firewall rule in the MikroTik(A) drops all packets from the WAN link of ISP1 to the hosts (8.8.8.8 and 204.67.220.220).
- The backup WAN link (to ISP2) should take over all packets to the Internet.

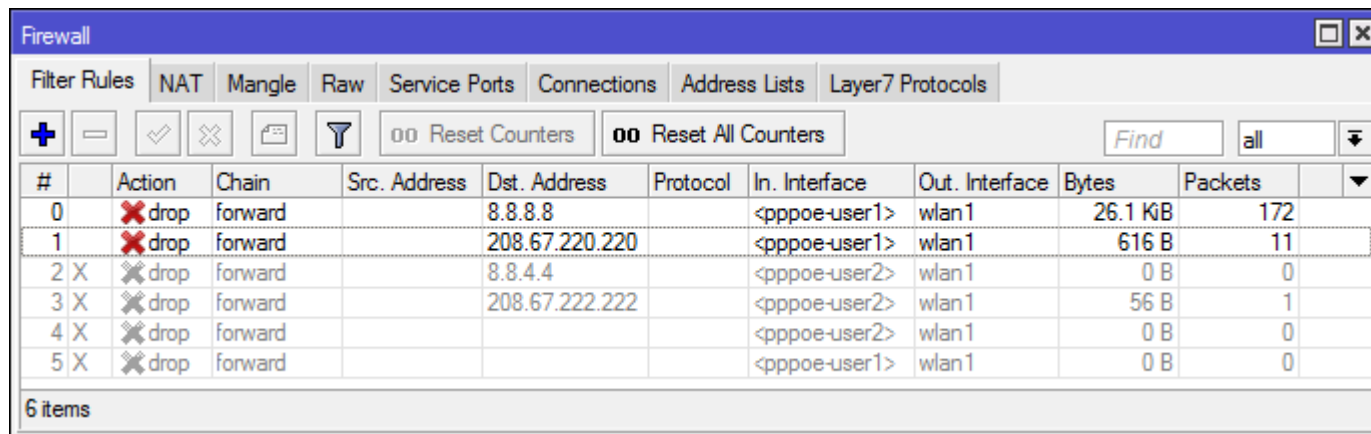

The screenshot shows the Mikrotik WinBox Firewall Filter Rules configuration window. The table displays the following data:

#	Action	Chain	Src. Address	Dst. Address	Protocol	In. Interface	Out. Interface	Bytes	Packets
0	✘ drop	forward		8.8.8.8		<pppoe-user1>	wlan1	26.1 KB	172
1	✘ drop	forward		208.67.220.220		<pppoe-user1>	wlan1	616 B	11
2	X ✘ drop	forward		8.8.4.4		<pppoe-user2>	wlan1	0 B	0
3	X ✘ drop	forward		208.67.222.222		<pppoe-user2>	wlan1	56 B	1
4	X ✘ drop	forward				<pppoe-user2>	wlan1	0 B	0
5	X ✘ drop	forward				<pppoe-user1>	wlan1	0 B	0

6 items

# Failover with Checking Multiple Remote Hosts

- **Testing:** failover with **checking multiple remote hosts** per WAN link
- **Scenario#1:** The **result** in the route list shows that the default route through the ISP1 is **unreachable**, and the default route through the ISP2 has taken over.

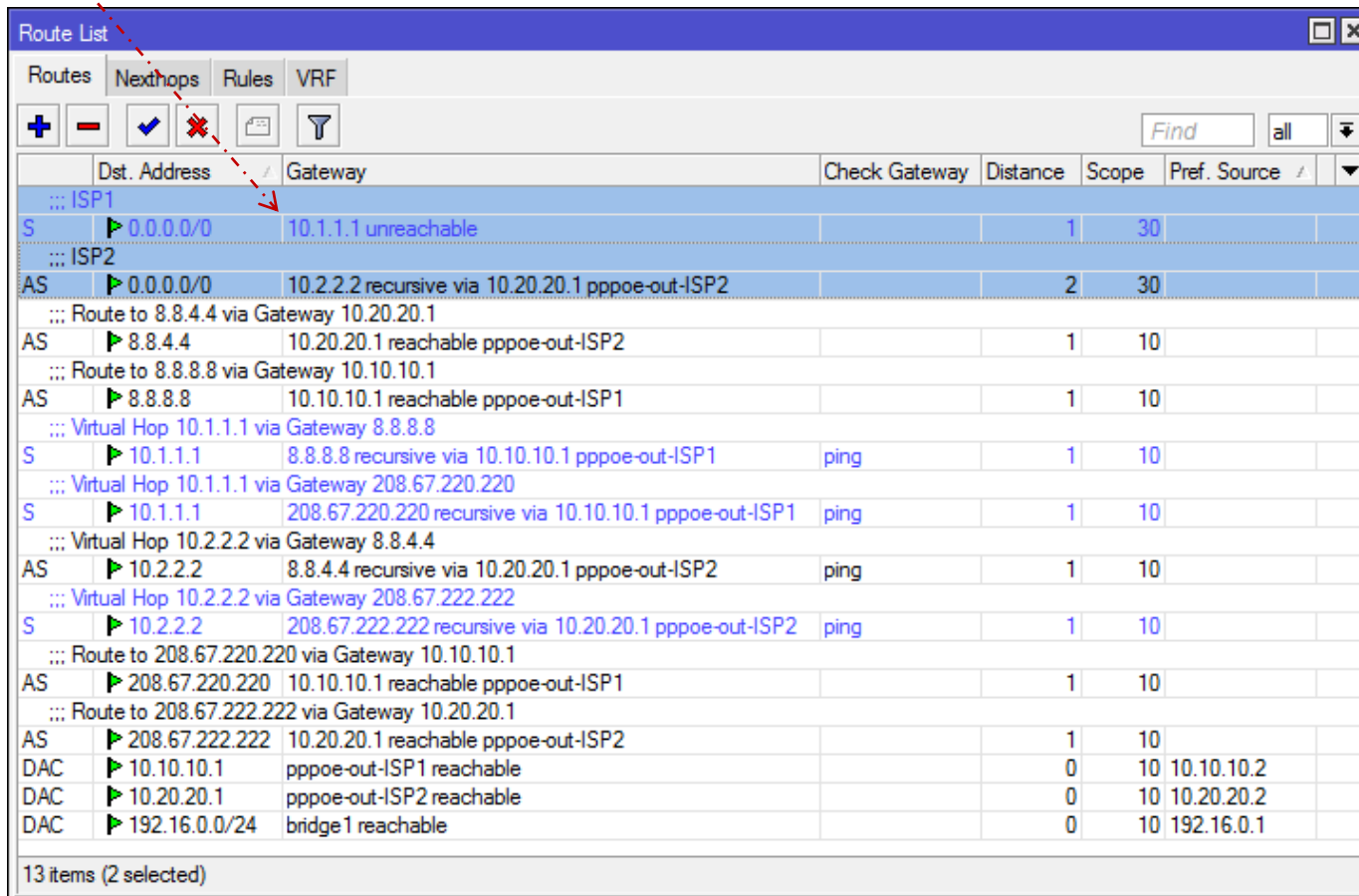

	Dst. Address	Gateway	Check Gateway	Distance	Scope	Pref. Source	
::: ISP1							
S	0.0.0.0/0	10.1.1.1 unreachable		1	30		
::: ISP2							
AS	0.0.0.0/0	10.2.2.2 recursive via 10.20.20.1 pppoe-out-ISP2		2	30		
::: Route to 8.8.4.4 via Gateway 10.20.20.1							
AS	8.8.4.4	10.20.20.1 reachable pppoe-out-ISP2		1	10		
::: Route to 8.8.8.8 via Gateway 10.10.10.1							
AS	8.8.8.8	10.10.10.1 reachable pppoe-out-ISP1		1	10		
::: Virtual Hop 10.1.1.1 via Gateway 8.8.8.8							
S	10.1.1.1	8.8.8.8 recursive via 10.10.10.1 pppoe-out-ISP1	ping	1	10		
::: Virtual Hop 10.1.1.1 via Gateway 208.67.220.220							
S	10.1.1.1	208.67.220.220 recursive via 10.10.10.1 pppoe-out-ISP1	ping	1	10		
::: Virtual Hop 10.2.2.2 via Gateway 8.8.4.4							
AS	10.2.2.2	8.8.4.4 recursive via 10.20.20.1 pppoe-out-ISP2	ping	1	10		
::: Virtual Hop 10.2.2.2 via Gateway 208.67.222.222							
S	10.2.2.2	208.67.222.222 recursive via 10.20.20.1 pppoe-out-ISP2	ping	1	10		
::: Route to 208.67.220.220 via Gateway 10.10.10.1							
AS	208.67.220.220	10.10.10.1 reachable pppoe-out-ISP1		1	10		
::: Route to 208.67.222.222 via Gateway 10.20.20.1							
AS	208.67.222.222	10.20.20.1 reachable pppoe-out-ISP2		1	10		
DAC	10.10.10.1	pppoe-out-ISP1 reachable		0	10	10.10.10.2	
DAC	10.20.20.1	pppoe-out-ISP2 reachable		0	10	10.20.20.2	
DAC	192.16.0.0/24	bridge1 reachable		0	10	192.16.0.1	





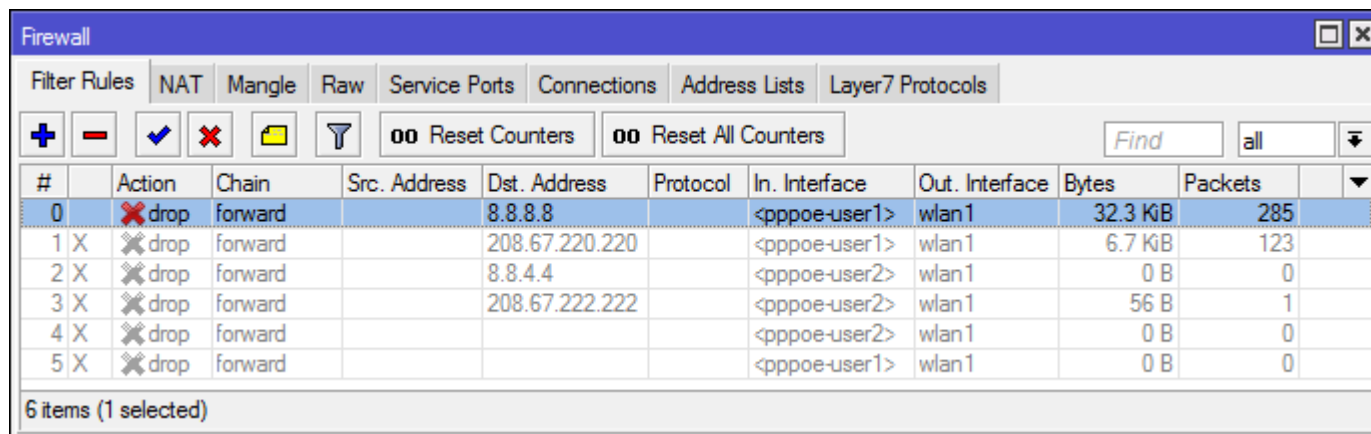

13 items (2 selected)

# Failover with Checking Multiple Remote Hosts

- **Testing:** failover with **checking multiple remote hosts** per WAN link
- **Scenario#2:** The ISP1 must be able to access the Internet, even if the **host (8.8.8.8) fails**. The firewall rule in the MikroTik(A) **drops all packets from the WAN link of ISP1 to only the hosts (8.8.8.8)**.
- The primary WAN link (to ISP1) should still take over all packets to the Internet.



The screenshot shows the Mikrotik WinBox Firewall Filter Rules configuration window. The 'Filter Rules' tab is active, and the table below displays the configured rules. Rule 0 is selected, showing it is configured to drop traffic from the source address 8.8.8.8 on the <pppoe-user1> interface to the wlan1 interface.

#	Action	Chain	Src. Address	Dst. Address	Protocol	In. Interface	Out. Interface	Bytes	Packets
0	 drop	forward		8.8.8.8		<pppoe-user1>	wlan1	32.3 KiB	285
1	X  drop	forward		208.67.220.220		<pppoe-user1>	wlan1	6.7 KiB	123
2	X  drop	forward		8.8.4.4		<pppoe-user2>	wlan1	0 B	0
3	X  drop	forward		208.67.222.222		<pppoe-user2>	wlan1	56 B	1
4	X  drop	forward				<pppoe-user2>	wlan1	0 B	0
5	X  drop	forward				<pppoe-user1>	wlan1	0 B	0

6 items (1 selected)

# Failover with Checking Multiple Remote Hosts

- **Testing:** failover with **checking multiple remote hosts** per WAN link
- **Scenario#2:** The **result** in the route list shows that the default route through the ISP1 is **reachable** via the ISP1 gateway (10.10.10.1).

	Dst. Address	Gateway	Check Gateway	Distance	Scope	Pref. Source
::: ISP1						
AS	▶ 0.0.0.0/0	10.1.1.1 recursive via 10.10.10.1 pppoe-out-ISP1		1	30	
::: ISP2						
S	▶ 0.0.0.0/0	10.2.2.2 recursive via 10.20.20.1 pppoe-out-ISP2		2	30	
::: Route to 8.8.4.4 via Gateway 10.20.20.1						
AS	▶ 8.8.4.4	10.20.20.1 reachable pppoe-out-ISP2		1	10	
::: Route to 8.8.8.8 via Gateway 10.10.10.1						
AS	▶ 8.8.8.8	10.10.10.1 reachable pppoe-out-ISP1		1	10	
::: Virtual Hop 10.1.1.1 via Gateway 8.8.8.8						
S	▶ 10.1.1.1	8.8.8.8 recursive via 10.10.10.1 pppoe-out-ISP1	ping	1	10	
::: Virtual Hop 10.1.1.1 via Gateway 208.67.220.220						
AS	▶ 10.1.1.1	208.67.220.220 recursive via 10.10.10.1 pppoe-out-ISP1	ping	1	10	
::: Virtual Hop 10.2.2.2 via Gateway 8.8.4.4						
AS	▶ 10.2.2.2	8.8.4.4 recursive via 10.20.20.1 pppoe-out-ISP2	ping	1	10	
::: Virtual Hop 10.2.2.2 via Gateway 208.67.222.222						
S	▶ 10.2.2.2	208.67.222.222 recursive via 10.20.20.1 pppoe-out-ISP2	ping	1	10	
::: Route to 208.67.220.220 via Gateway 10.10.10.1						
AS	▶ 208.67.220.220	10.10.10.1 reachable pppoe-out-ISP1		1	10	
::: Route to 208.67.222.222 via Gateway 10.20.20.1						
AS	▶ 208.67.222.222	10.20.20.1 reachable pppoe-out-ISP2		1	10	
DAC	▶ 10.10.10.1	pppoe-out-ISP1 reachable		0	10	10.10.10.2
DAC	▶ 10.20.20.1	pppoe-out-ISP2 reachable		0	10	10.20.20.2
DAC	▶ 192.16.0.0/24	bridge1 reachable		0	10	192.16.0.1

13 items (2 selected)



# Failover with Checking Multiple Remote Hosts

- **Testing:** failover with **checking multiple remote hosts** per WAN link
- **Scenario#3:** All hosts (8.8.8.8, 208.67.220.220, 8.8.4.4, and 208.67.222.222) fails.
- The firewall rule in the MikroTik(A) drops all packets as follows.
  - ✓ From the WAN link of ISP1 to the hosts (8.8.8.8, 208.67.220.220)
  - ✓ From the WAN link of ISP2 to the hosts (8.8.4.4, 208.67.222.222)

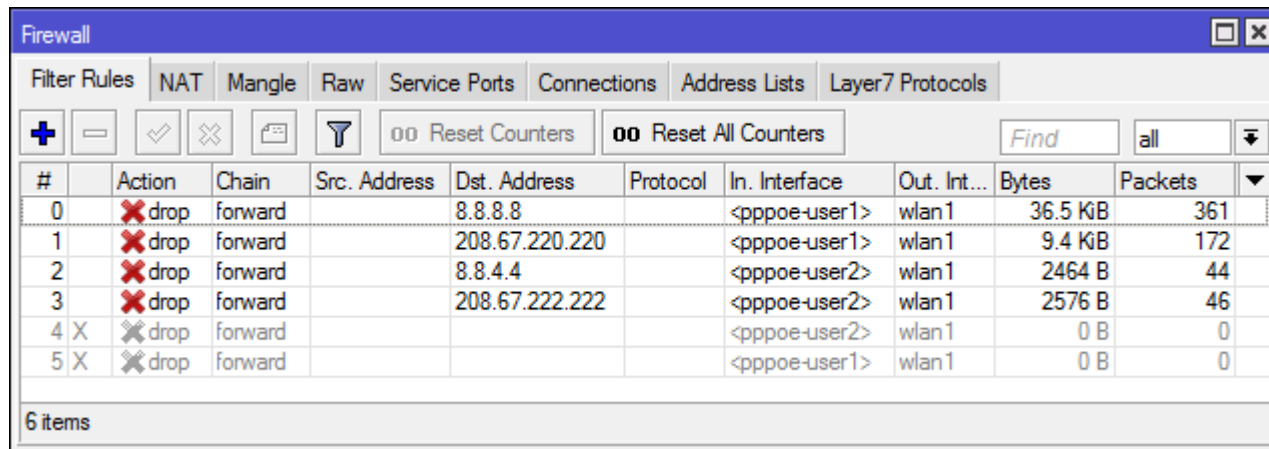

The screenshot shows the Mikrotik WinBox Firewall Filter Rules configuration. The table displays the following data:

#	Action	Chain	Src. Address	Dst. Address	Protocol	In. Interface	Out. Int...	Bytes	Packets
0	✗ drop	forward		8.8.8.8		<pppoe-user1>	wlan1	36.5 KB	361
1	✗ drop	forward		208.67.220.220		<pppoe-user1>	wlan1	9.4 KB	172
2	✗ drop	forward		8.8.4.4		<pppoe-user2>	wlan1	2464 B	44
3	✗ drop	forward		208.67.222.222		<pppoe-user2>	wlan1	2576 B	46
4	X ✗ drop	forward				<pppoe-user2>	wlan1	0 B	0
5	X ✗ drop	forward				<pppoe-user1>	wlan1	0 B	0

6 items

# Failover with Checking Multiple Remote Hosts

- **Testing:** failover with **checking multiple remote hosts** per WAN link
- **Scenario#3:** The **result** in the route list shows that the default route through **both ISP1 and ISP2 are unreachable.**

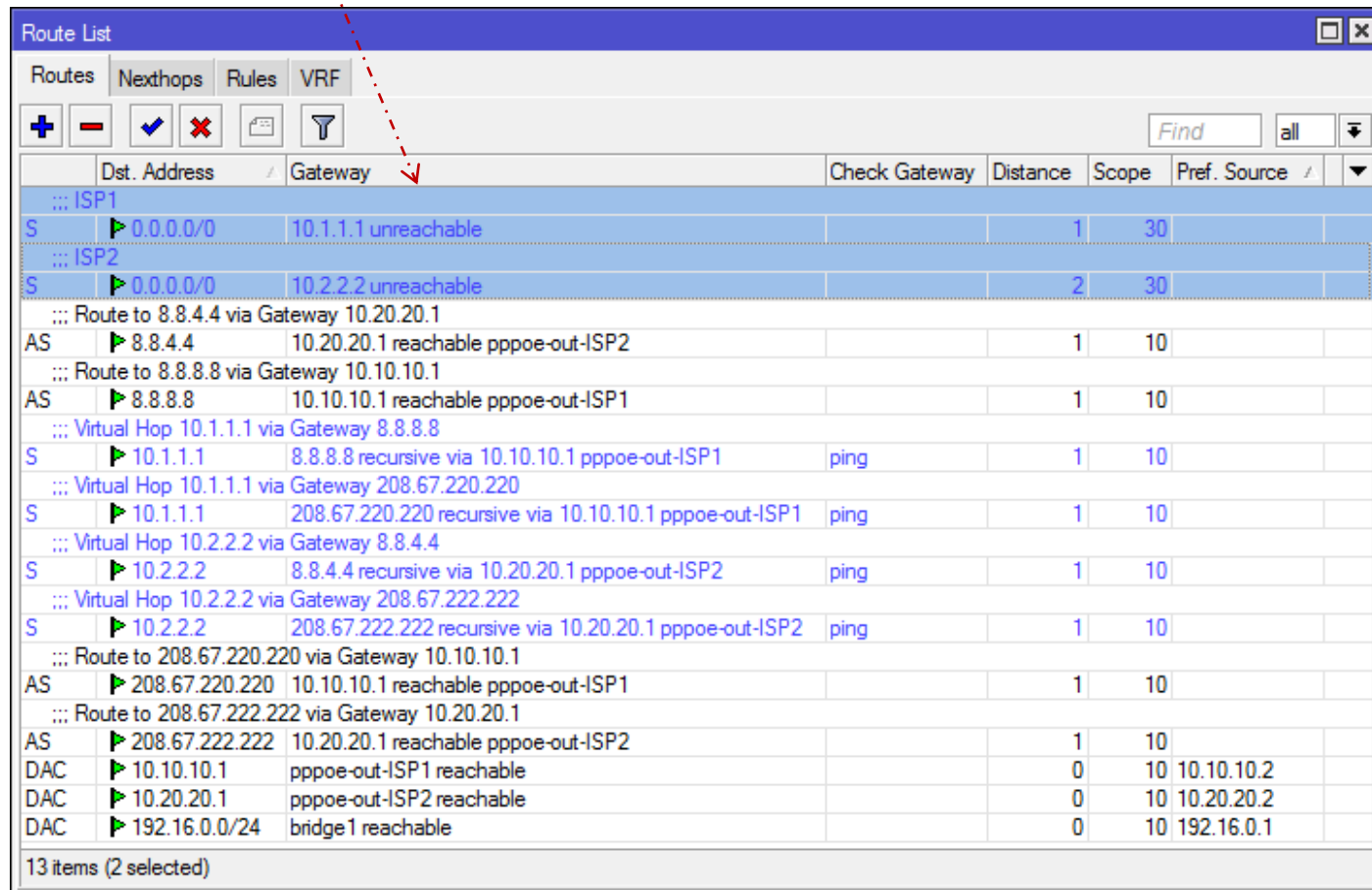

	Dist. Address	Gateway	Check Gateway	Distance	Scope	Pref. Source	
::: ISP1							
S	▶ 0.0.0.0/0	10.1.1.1 unreachable		1	30		
::: ISP2							
S	▶ 0.0.0.0/0	10.2.2.2 unreachable		2	30		
::: Route to 8.8.4.4 via Gateway 10.20.20.1							
AS	▶ 8.8.4.4	10.20.20.1 reachable pppoe-out-ISP2		1	10		
::: Route to 8.8.8.8 via Gateway 10.10.10.1							
AS	▶ 8.8.8.8	10.10.10.1 reachable pppoe-out-ISP1		1	10		
::: Virtual Hop 10.1.1.1 via Gateway 8.8.8.8							
S	▶ 10.1.1.1	8.8.8.8 recursive via 10.10.10.1 pppoe-out-ISP1	ping	1	10		
::: Virtual Hop 10.1.1.1 via Gateway 208.67.220.220							
S	▶ 10.1.1.1	208.67.220.220 recursive via 10.10.10.1 pppoe-out-ISP1	ping	1	10		
::: Virtual Hop 10.2.2.2 via Gateway 8.8.4.4							
S	▶ 10.2.2.2	8.8.4.4 recursive via 10.20.20.1 pppoe-out-ISP2	ping	1	10		
::: Virtual Hop 10.2.2.2 via Gateway 208.67.222.222							
S	▶ 10.2.2.2	208.67.222.222 recursive via 10.20.20.1 pppoe-out-ISP2	ping	1	10		
::: Route to 208.67.220.220 via Gateway 10.10.10.1							
AS	▶ 208.67.220.220	10.10.10.1 reachable pppoe-out-ISP1		1	10		
::: Route to 208.67.222.222 via Gateway 10.20.20.1							
AS	▶ 208.67.222.222	10.20.20.1 reachable pppoe-out-ISP2		1	10		
DAC	▶ 10.10.10.1	pppoe-out-ISP1 reachable		0	10	10.10.10.2	
DAC	▶ 10.20.20.1	pppoe-out-ISP2 reachable		0	10	10.20.20.2	
DAC	▶ 192.16.0.0/24	bridge1 reachable		0	10	192.16.0.1	

13 items (2 selected)

# Failover with Checking Multiple Remote Hosts

- **Testing:** failover with **checking multiple remote hosts** per WAN link
- **Scenario#4:** All hosts (8.8.8.8, 208.67.220.220, and 8.8.4.4) fails **but only the host (208.67.222.222) is fine.**
- The firewall rule in the MikroTik(A) drops all packets as follows.
  - ✓ From the WAN link of ISP1 to the hosts (8.8.8.8, 208.67.220.220)
  - ✓ From the WAN link of ISP2 to the hosts (8.8.4.4)

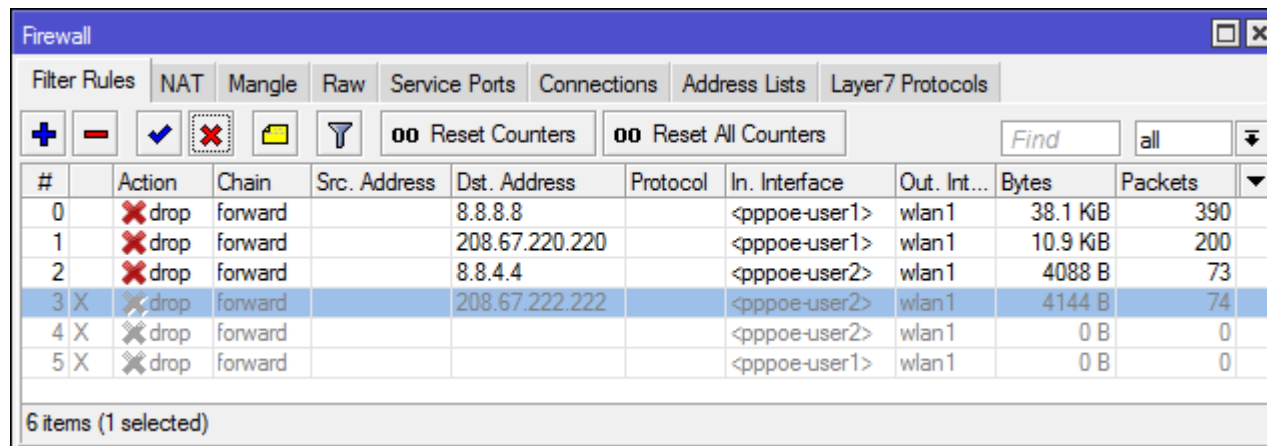

The screenshot shows the Mikrotik WinBox Firewall Filter Rules configuration window. The 'Filter Rules' tab is active, displaying a table of rules. Rule 3 is selected, showing a 'drop' action for traffic from <pppoe-user2> to 208.67.222.222 on wlan1. Rules 0, 1, and 2 are also shown, all with 'drop' actions for different destinations (8.8.8.8, 208.67.220.220, and 8.8.4.4). Rules 4 and 5 are disabled (indicated by 'X' in the # column) and also have 'drop' actions.

#	Action	Chain	Src. Address	Dst. Address	Protocol	In. Interface	Out. Int...	Bytes	Packets
0	✗ drop	forward		8.8.8.8		<pppoe-user1>	wlan1	38.1 KB	390
1	✗ drop	forward		208.67.220.220		<pppoe-user1>	wlan1	10.9 KB	200
2	✗ drop	forward		8.8.4.4		<pppoe-user2>	wlan1	4088 B	73
3 X	✗ drop	forward		208.67.222.222		<pppoe-user2>	wlan1	4144 B	74
4 X	✗ drop	forward				<pppoe-user2>	wlan1	0 B	0
5 X	✗ drop	forward				<pppoe-user1>	wlan1	0 B	0

# Failover with Checking Multiple Remote Hosts

- **Testing:** failover with **checking multiple remote hosts** per WAN link
- **Scenario#4:** The **result** in the route list shows that the default route through **the ISP1 is unreachable** but the default route of ISP2 has taken over all traffic to the Internet.

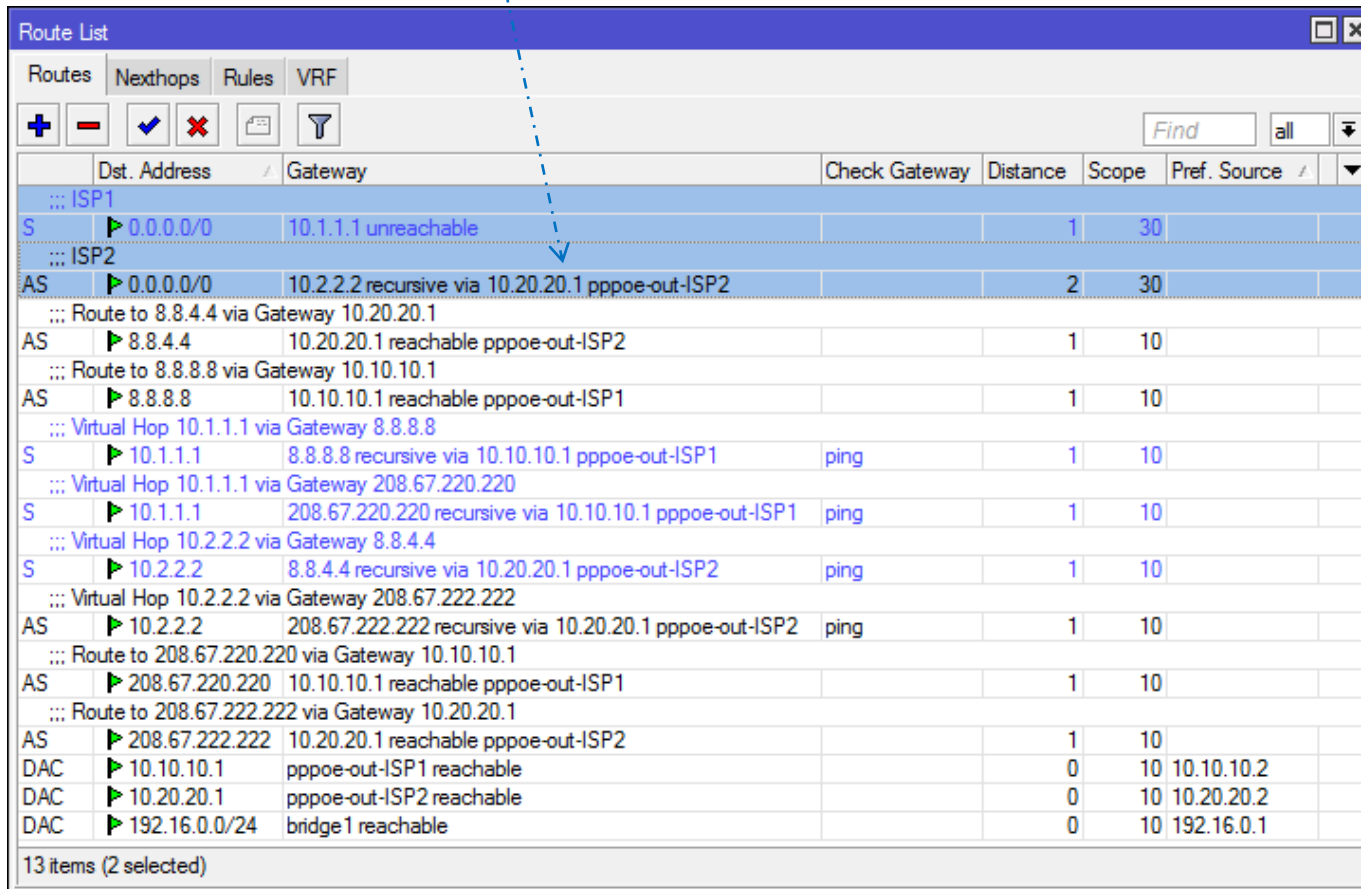

	Dist. Address	Gateway	Check Gateway	Distance	Scope	Pref. Source
::: ISP1						
S	0.0.0.0/0	10.1.1.1 unreachable		1	30	
::: ISP2						
AS	0.0.0.0/0	10.2.2.2 recursive via 10.20.20.1 pppoe-out-ISP2		2	30	
::: Route to 8.8.4.4 via Gateway 10.20.20.1						
AS	8.8.4.4	10.20.20.1 reachable pppoe-out-ISP2		1	10	
::: Route to 8.8.8.8 via Gateway 10.10.10.1						
AS	8.8.8.8	10.10.10.1 reachable pppoe-out-ISP1		1	10	
::: Virtual Hop 10.1.1.1 via Gateway 8.8.8.8						
S	10.1.1.1	8.8.8.8 recursive via 10.10.10.1 pppoe-out-ISP1	ping	1	10	
::: Virtual Hop 10.1.1.1 via Gateway 208.67.220.220						
S	10.1.1.1	208.67.220.220 recursive via 10.10.10.1 pppoe-out-ISP1	ping	1	10	
::: Virtual Hop 10.2.2.2 via Gateway 8.8.4.4						
S	10.2.2.2	8.8.4.4 recursive via 10.20.20.1 pppoe-out-ISP2	ping	1	10	
::: Virtual Hop 10.2.2.2 via Gateway 208.67.222.222						
AS	10.2.2.2	208.67.222.222 recursive via 10.20.20.1 pppoe-out-ISP2	ping	1	10	
::: Route to 208.67.220.220 via Gateway 10.10.10.1						
AS	208.67.220.220	10.10.10.1 reachable pppoe-out-ISP1		1	10	
::: Route to 208.67.222.222 via Gateway 10.20.20.1						
AS	208.67.222.222	10.20.20.1 reachable pppoe-out-ISP2		1	10	
DAC	10.10.10.1	pppoe-out-ISP1 reachable		0	10	10.10.10.2
DAC	10.20.20.1	pppoe-out-ISP2 reachable		0	10	10.20.20.2
DAC	192.16.0.0/24	bridge 1 reachable		0	10	192.16.0.1

# Failover with Checking Multiple Remote Hosts

- Failover with **checking multiple remote hosts** per WAN link
- In case of **load balancing**, you have corresponding **routing masks** (toISP1, toISP2)
- The **first step 1)** is revised (**adding default routes and changing distances**) as follow
  - /ip route
    - add distance=1 gateway=10.1.1.1 routing-mask=toISP1
    - add distance=2 gateway=10.2.2.2 routing-mask=toISP1
  - /ip route
    - add distance=1 gateway=10.2.2.2 routing-mask=toISP2
    - add distance=2 gateway=10.1.1.1 routing-mask=toISP2

# Thank You for Your Attention

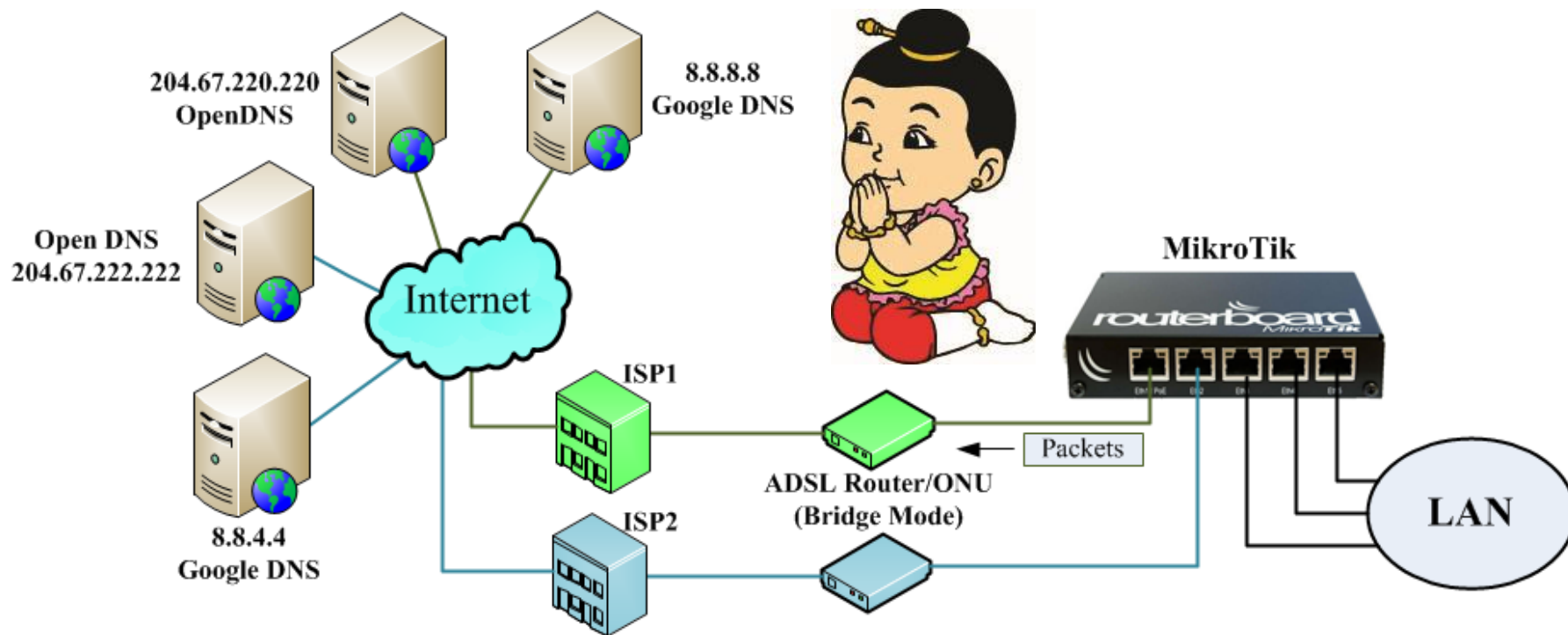

## Reference

[1] <https://wiki.mikrotik.com/wiki/Manual:IP/Route>

[2] [https://wiki.mikrotik.com/wiki/Advanced\\_Routing\\_Failover\\_without\\_Scripting](https://wiki.mikrotik.com/wiki/Advanced_Routing_Failover_without_Scripting)